

PCB LAYOUT

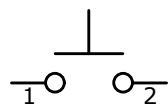

▲ CIRCUIT: SPST

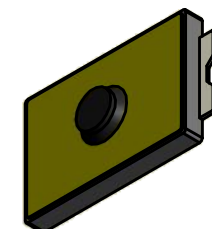
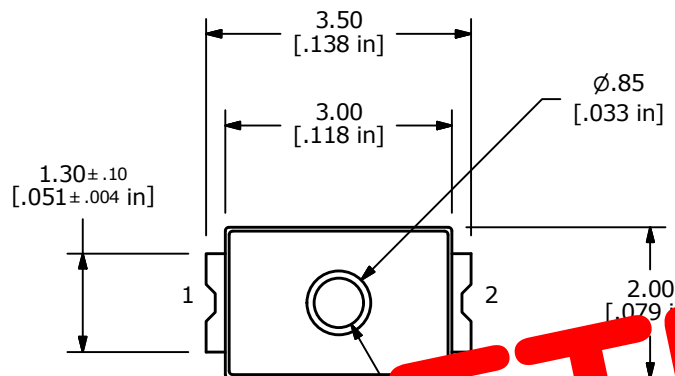

OBSOLETE
 Jan. 2017
 PCR 22678

NOTES:

1. ALL DIMENSIONS IN MM [INCH]
 x.x = +/-0.4
 x.xx = +/-0.25
2. TERMINAL NUMBERS FOR REF. ONLY
3. CONTACT MATERIAL: SILVER
4. CONTACT RATING: 50 mA; 12 VDC
5. TRAVEL: 0.13 ± 0.05mm
- ▲ 6. OPERATING FORCE: 240 ± 70 GRAMS
7. ELECTRICAL LIFE: 300,000 CYCLES
8. CONTACT RESISTANCE: 500mΩ MAX.
9. ▲ DENOTES CRITICAL PARAMETER
10. BOUNCE: 10m SECONDS MAX
11. INSULATION RESISTANCE: 100MΩ MIN @ 100VDC.
12. DIELECTRIC STRENGTH: 100VAC FOR 1 MINUTE WITH NO BREAK DOWN
13. 2002/95/EC (ROHS) COMPLIANT; HALOGEN FREE

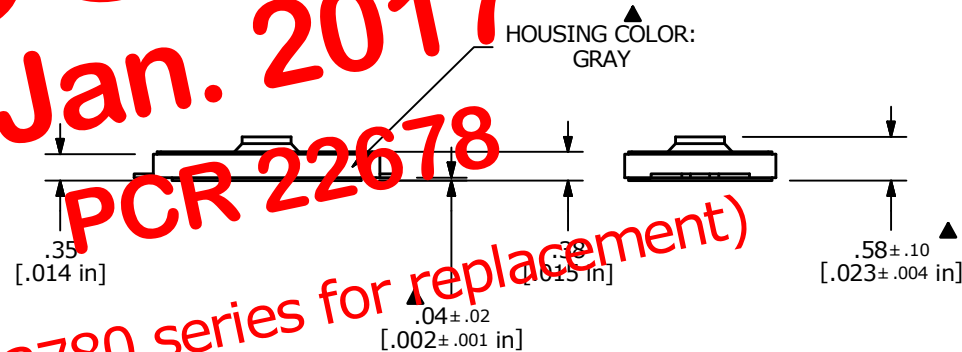

(See 3780 series for replacement)



TITLE TL3750AF240QG				
SCALE 10:1	DATE 2/17/2015	DR rc	DWG P003102	REV A

A	21789	New Release	2/17/15	rc
REV	PCR NO	DESCRIPTION	DATE	BY

THE INFORMATION CONTAINED IN THIS DOCUMENT IS PROPRIETARY TO E-SWITCH AND IS NOT TO BE COPIED OR TRANSFERRED